







## Mass Flow Meter (MFM)

- Nominal flow ranges from 20 IN/min up to 2500 IN/min
- High accuracy
- Fast response time
- Protection class IP65
- Optional: Fieldbus interface

Product variants described in the data sheet may differ from the product presentation and description.

### Can be combined with

	<b>Type 8611</b> eCONTROL - Universal controller	▶
	<b>Type 0330</b> Direct-acting 2/2 or 3/2 way pivoted armature valve	▶
	<b>Type 8619</b> multiCELL - Multi-channel and multi-function transmitter/controller	▶
	<b>Type 6027</b> Direct-acting 2/2 way plunger valve	▶

### Type description

The mass flow meter (MFM) type 8006 is suited for measuring the mass flow of high gas flows. The thermal inline sensor is located directly in the gas stream and therefore reaches very fast response times. Type 8006 can optionally be calibrated for two different gases; the user can switch between these two gases. As electrical interfaces both, analog standard signals and fieldbuses are available. The MFM type 8006 is especially designed for use in harsh environments due to a low sensitivity to contamination and the high protection class.

## Table of contents

<b>1. General technical data</b>	<b>3</b>
<b>2. Materials</b>	<b>4</b>
2.1. Chemical Resistance Chart – Bürkert resistApp.....	4
<b>3. Dimensions</b>	<b>5</b>
3.1. MFM.....	5
3.2. MFM for large nominal flow rates .....	6
<b>4. Device / process connections</b>	<b>7</b>
4.1. Pin assignment .....	7
<b>5. Performance specifications</b>	<b>9</b>
5.1. Pressure loss diagram of MFM .....	9
5.2. Flow characteristic.....	9
Nominal flow range of typical gases.....	9
<b>6. Product operation</b>	<b>10</b>
6.1. Measuring principle .....	10
<b>7. Ordering information</b>	<b>11</b>
7.1. Bürkert eShop – Easy ordering and quick delivery.....	11
7.2. Recommendation regarding product selection .....	11
7.3. Bürkert product filter.....	11
7.4. Ordering chart accessories.....	11
7.5. Adapter sketch.....	12

## 1. General technical data

Product properties	
Dimensions	Detailed information can be found in chapter "3. Dimensions" on page 5.
Materials	
Housing	Aluminium (black anodized) or stainless steel
Body	Aluminium (coated)
Seal	FKM or EPDM (depending on gas)
Weight	1.2 kg (AI) 3.0 kg (VA)
LED display	Indication for: 1. Power 2. Communication 3. Limit 4. Error
Performance data	
Operating pressure (max.)	10 bar...25 bar (N <sub>2</sub> , air, Argon)
Response time (t <sub>95</sub> %)	<500 ms
Nominal flow range <sup>1)</sup> (Q <sub>Nom</sub> )	20...2500 l <sub>N</sub> /min <sup>2)</sup> , Reference medium N <sub>2</sub> Detailed information can be found in chapter "5.2. Flow characteristic" on page 9.
Measuring accuracy	±1.5 % o. R. <sup>3)</sup> ±0.3 % F. S. <sup>4)</sup>
Repeatability	±0.1 % F. S.
Measuring range	1:50 (With vertical installation position with flow from top to bottom the measuring range is 1:10)
Electrical data	
Electrical connection	
Standard	Socket M16, round, 8 pin and socket D-Sub HD15, 15 pin
Additionally for PROFIBUS DP	M12 socket, 5 pin or D-Sub 9 pin
Additionally for CANopen	Plug M12, 5 pin or D-Sub 9 pin
RS485 version only	Plug D-Sub 9 pin
Operating voltage	24 V DC
Power consumption (max.)	3.5...10 W for fieldbus: 4...12.5 W (depending on version)
Residual ripple (at DC)	<2 %
Voltage tolerance	±10 %
Medium data	
Operating medium	Neutral, non-contaminated gases, others on request
Calibration medium	Operating gas or air with conversion factor
Temperature of gas	-10...+70 °C (-10...+60 °C for oxygen)
Process/Port connection & communication	
Port connection	G ¼, G ⅜, G ½, G ¾, G 1 NPT ¼, NPT ⅜, NPT ½, NPT ¾, NPT 1 With screw-in fitting For more detailed information, please refer to the <b>product enquiry form</b> at the end of the document.
Analogue communication	
Output signal (Actual value)	Analogue signal version: 0...5 V, 0...10 V, 0...20 mA or 4...20 mA Field bus version: None RS485 version (only D-Sub, 9 pin): None
Max. Current Voltage output	Analogue signal version: 10 mA Field bus version: None RS485 version (only D-Sub, 9 pin): None
Max. Load current output	Analogue signal version: 600 Ω Field bus version: None RS485 version (only D-Sub, 9 pin): None
Fieldbus option	
(D-Sub HD15 covered by sealing cap), pins for analogue inputs/outputs not assigned)	Analogue signal version: None Fieldbus version: PROFIBUS-DP, CANopen RS485 version (only D-Sub, 9 pin): Modbus RTU (via RS interface)

**Digital communication**

Possible via adapter: Analogue signal version: RS232 (supports Modbus RTU)  
RS485, RS422 or USB  
Fieldbus version: None  
Possible via adapter: RS485 version (only D-Sub, 9 pin): RS485, RS422  
USB

**Binary inputs**

(Default, other functions selectable) Analog signal version: Three: 1. not assigned / 2. not assigned/ 3. not assigned  
Fieldbus version: Three: 1. not assigned / 2. not assigned / 3. not assigned  
RS485 version (only D-Sub, 9 pin): One: not assigned

**Binary outputs**

(Default, other functions selectable) Analog signal version: Two relay outputs: 1. Limit ( $Q_{Nom}$  almost reached)  
2. Error (e.g. sensor fault)  
Load capacity: max. 60 V, 1 A, 60 VA  
Fieldbus version: Two relay outputs: 1. Limit ( $Q_{Nom}$  almost reached)  
2. Error (e.g. sensor fault)  
Load capacity: max. 60 V, 1 A, 60 VA  
RS485 version (only D-Sub, 9 pin): One relay output: 1. Limit ( $Q_{Nom}$  almost reached)  
Load capacity: max. 25 V, 1 A, 25 VA

**Environment and installation**

Installation position Horizontal or vertical  
Ambient temperature - 10...+45 °C (higher temperatures on request)  
Degree of protection IP65  
(with connected cables)

- 1.) The nominal flow rate is the largest calibrated and measurable flow rate value.  
The nominal flow range indicates the range of possible nominal flow values.
- 2.) Index N: Flow values with respect to 1.013 bar and 0 °C, alternatively  
Index S: flow values with respect to 1.013 bar and 20 °C

**2. Materials**

**2.1. Chemical Resistance Chart – Bürkert resistApp**

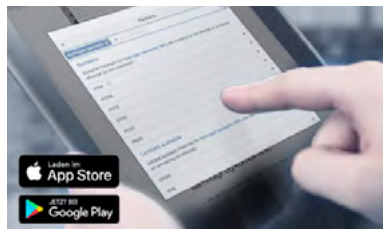

**Bürkert resistApp – Chemical Resistance Chart**

You want to ensure the reliability and durability of the materials in your individual application case? Verify your combination of media and materials on our website or in our resistApp.

[Start Chemical Resistance Check](#)

DTS 1000017532 EN Version: Q Status: RL (released | freigegeben | valide) printed: 06.08.2021

### 3. Dimensions

#### 3.1. MFM

**Note:**

Dimensions in mm

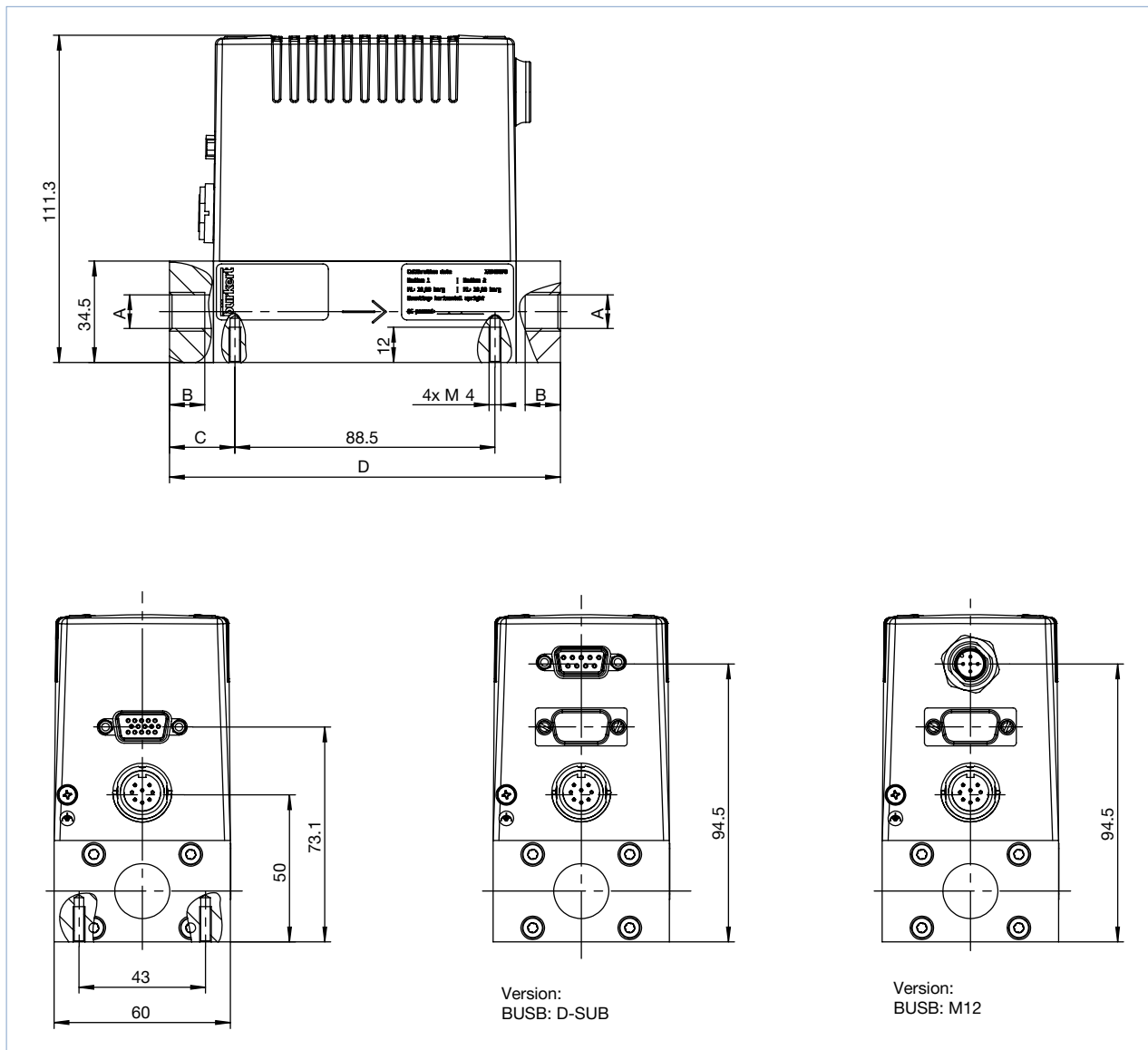

A	B	C	D
G 1/4; NPT 1/4	10	22.25	133
G 3/8; NPT 3/8	10	22.25	133
G 1/2; NPT 1/2	13	27.25	143
G 3/4; NPT 3/4	14	27.25	143

### 3.2. MFM for large nominal flow rates

**Note:**

Dimensions in mm

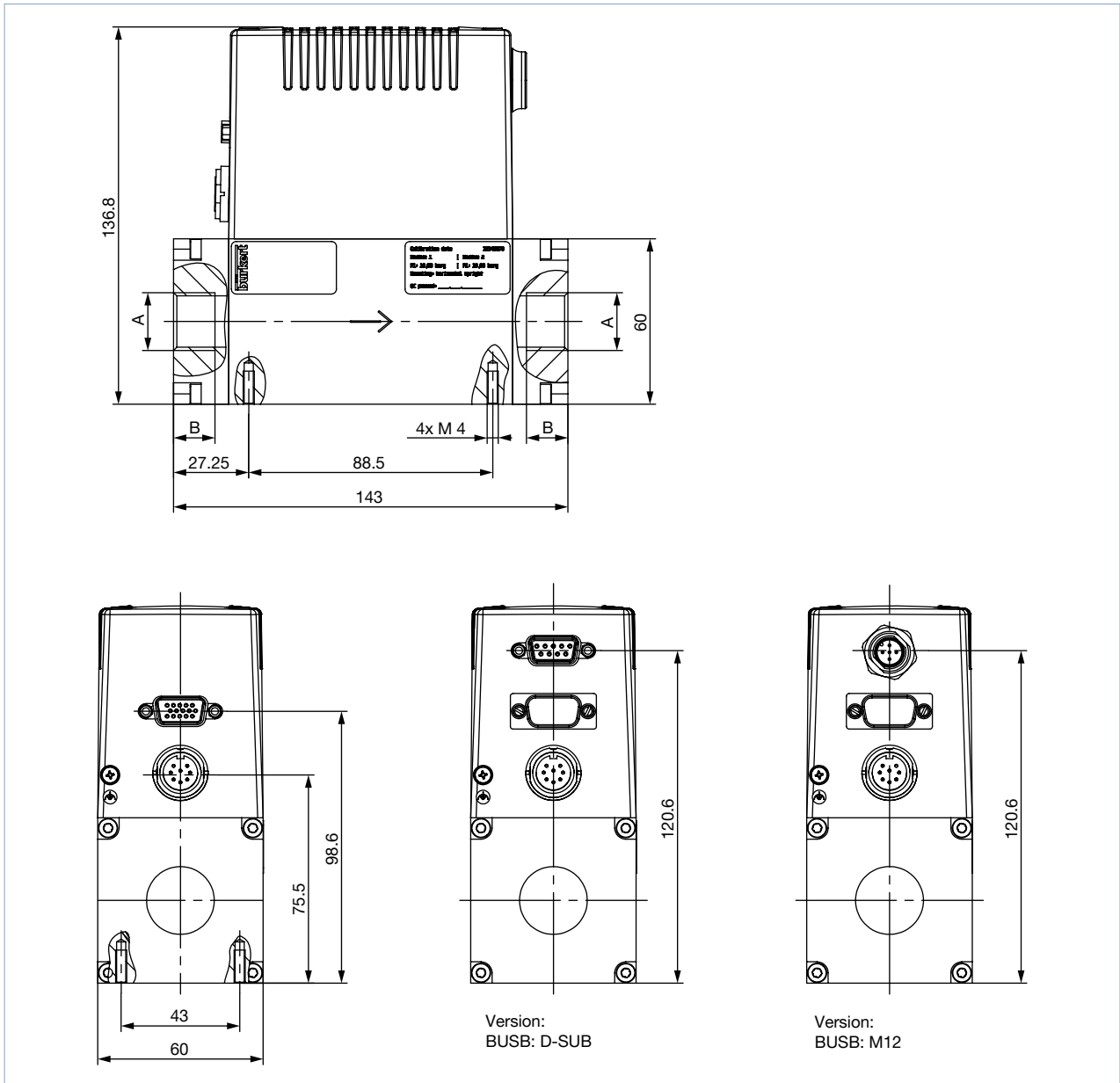

A	B
G 1/2; NPT 1/2	14
G 3/4; NPT 3/4	15
G 1	17

DTS 1000017532 EN Version: Q Status: RL (released | freigegeben | valide) printed: 06.08.2021

## 4. Device / process connections

### 4.1. Pin assignment

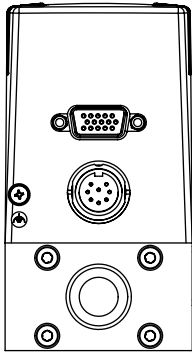

Standard

Terminal block 4 pin	Pin	Assignment	
		Analogue control unit	Bus actuation
	1	Not connected	Not connected
	2	Not connected	Not connected
	3	Actual value output +	Not connected
	4	Binary input 2	
	5	12 V-Output (only for factory use)	
	6	RS232 TxD (direct connection to computer)	
	7	Binary input 1	
	8	GND (for binary inputs)	
	9	Only internal use (do not occupy!)	
	10	12 V-Output (only for factory use)	
	11	12 V-Output (only for factory use)	
	12	Binary input 3	
	13	Actual value output GND	Not connected
	14	RS232 RxD (direct connection to computer)	
	15	DGND (for RS232-interface)	

Socket M16 round 8 pin	Pin	Assignment
	1	24 V-Supply +
	2	Relay 1 – reference contact
	3	Relay 2 – reference contact
	4	Relay 1 – Normally closed contact
	5	Relay 1 – Normally open contact
	6	24 V-Supply GND
	7	Relay 2 – Normally open contact
	8	Relay 2 – Normally closed contact

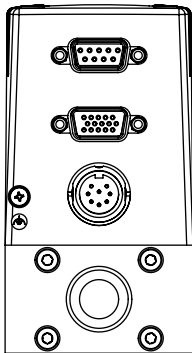

Fieldbus D-SUB

Socket D-Sub 9 pin (only for fieldbus version)	Pin	Assignment	
		PROFIBUS DP	CANopen
	1	Shield	Shield
	2	Not connected	CAN-L data line
	3	RxD/TxD - P (B-line)	GND
	4	RTS (control signal for repeater)	Not connected
	5	GND	Not connected
	6	VDD (only for termination resistor)	Not connected
	7	Not connected	CAN-H data line
	8	RxD/TxD - N (A-line)	Not connected
	9	Not connected	Not connected

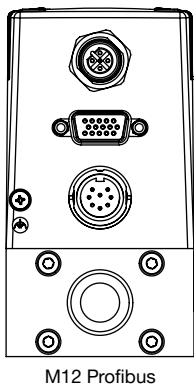

M12 Profibus

**PROFIBUS DP – Socket B-coded M12 (DPV1 max. 12 Mbaud)**

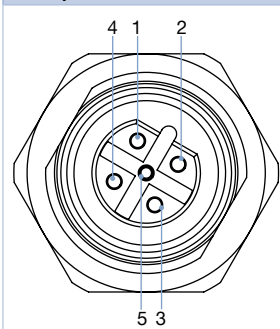

Pin	Assignment
1	VDD (only for termination resistor)
2	RxD/TxD – N (A-line)
3	DGND
4	RxD/TxD – P (B-line)
5	Not connected

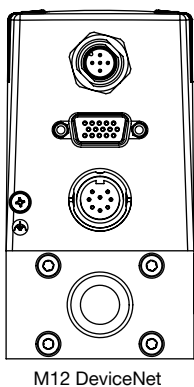

M12 DeviceNet

**CANopen – Plug A-coded M12**

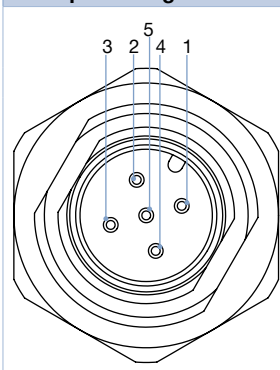

Pin	Assignment
1	Shield
2	Not connected
3	DGND
4	CAN_H
5	CAN_L

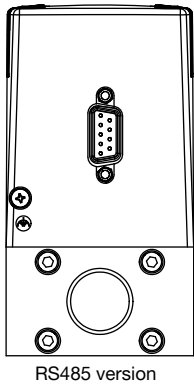

RS485 version

**Plug D-Sub 9 pin**

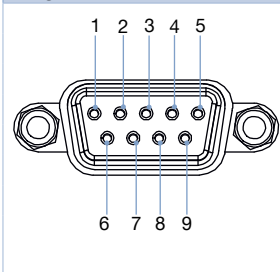

Pin	Assignment
1	Binary input (related to GND Pin2)
2	GND
3	Power supply +24 V DC
4	Relay, normally opened
5	Relay, normally closed
6	TX+ (RS485-Y) – bridge with pin 9 at half duplex
7	TX- (RS485-Z) – bridge with pin 8 at half duplex
8	RX- (RS485-B)
9	RX+ (RS485-A)

DTS 1000017532 EN Version: Q Status: RL (released | freigegeben | valide) printed: 06.08.2021



## 5. Performance specifications

### 5.1. Pressure loss diagram of MFM

The diagram shows exemplary the pressure loss characteristics when air flowing through. For determining the pressure loss with another gas it needs to calculate the air equivalent and respect the fluidics needed with the other gas.

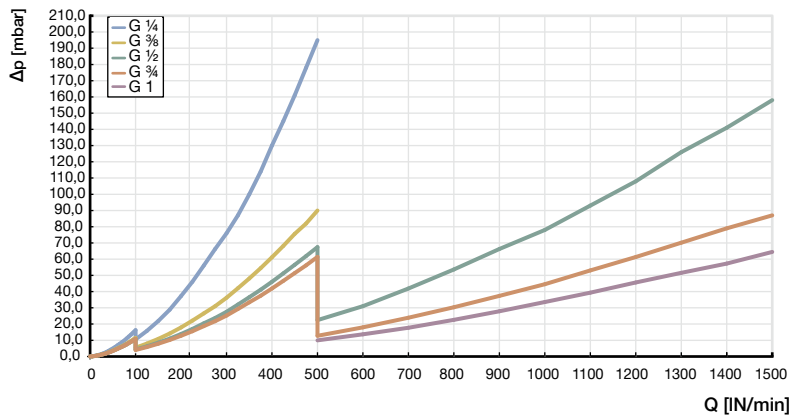

### 5.2. Flow characteristic

#### Nominal flow range of typical gases

**Note:**

All values regarding 1.013 bar(a) and 0 °C (Index N)

Gas	Min. Q <sub>Nom</sub> [l <sub>N</sub> /min]	Max. Q <sub>Nom</sub> [l <sub>N</sub> /min]
Acetylene	20	975
Ammonia	20	1250
Argon	20	1500
Carbon dioxide	20	800
Air	20	2500
Methane	20	750
Propane	20	400
Oxygen	20	2500
Nitrogen	20	2500

## 6. Product operation

### 6.1. Measuring principle

This sensor works as a hot-film anemometer in the so-called CTA operational mode (Constant Temperature Anemometer). To do this, two resistors with precisely specified temperature coefficients located directly in the media flow and three resistors located outside the flow are connected together to form a bridge.

The first resistor in the gas flow ( $R_T$ ) measures the fluid temperature, while the second, low-value resistor ( $R_S$ ) is heated so that it is maintained at a fixed, predefined over-temperature with respect to the fluid temperature.

The heating current required to maintain this is a measure of the heat being removed by the flowing gas, and represents the primary measurement.

An adequate flow conditioning within the MFM and the calibration with high-quality flow standards ensure that the mass of gas flowing per time unit can be derived from the primary signal with high accuracy.

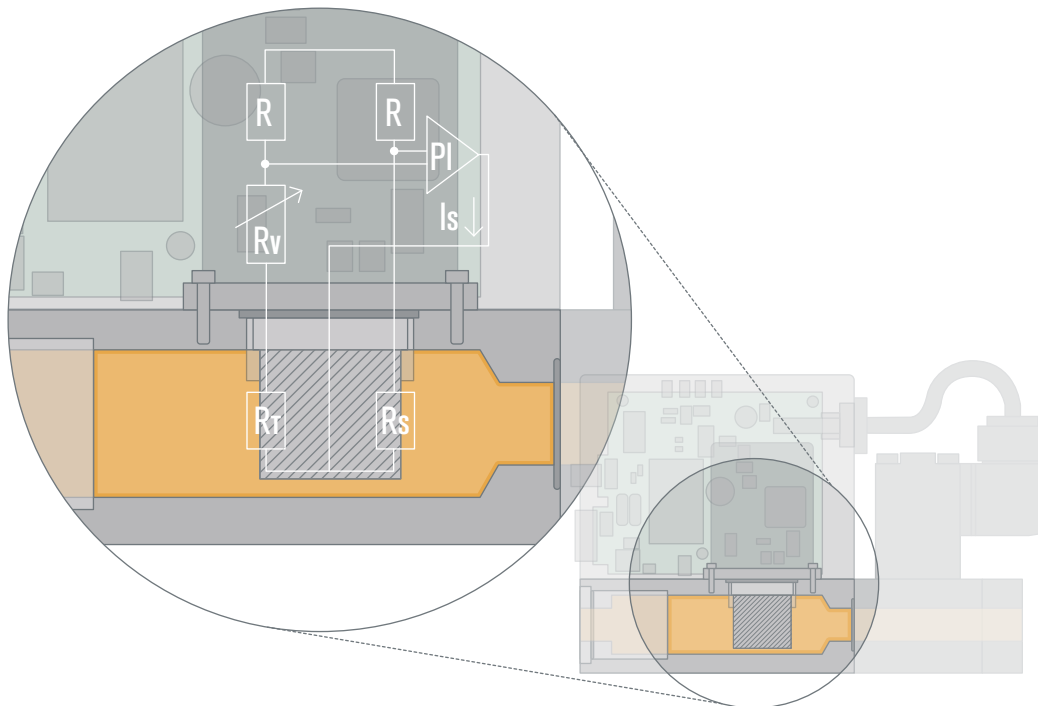

## 7. Ordering information

### 7.1. Bürkert eShop – Easy ordering and quick delivery



**Bürkert eShop – Easy ordering and fast delivery**

You want to find your desired Bürkert product or spare part quickly and order directly? Our online shop is available for you 24/7. Sign up and enjoy all the benefits.

[Order online now](#)

### 7.2. Recommendation regarding product selection

**Note:**

The **Product Enquiry Form** at the end of this document contains the relevant fluid specification. Using the experience of Bürkert engineers already in the design phase provide us with a copy of the request containing the necessary data together with your inquiry or order.

For the proper choice of the actuator orifice within the MFM, not only the required maximum flow rate  $Q_{Nom}$ , but also the pressure values directly before and after the MFM ( $p_1, p_2$ ) at this flow rate  $Q_{Nom}$  should be known. In general, these pressures are not the same as the overall inlet and outlet pressures of the whole plant, because usually there are additional flow resistors (tubing, additional shut-off valves, nozzles etc.) present both before and after the controller.

Please use the **Product Enquiry Form** at the end of this document to indicate the pressures directly before and after the MFM. If these are unknown or not accessible to a measurement, estimates are to be made by taking into account the approximate pressure drops over the flow resistors before and after the MFM, respectively, at a flow rate of  $Q_{Nom}$ . In addition, please quote the maximum inlet pressure  $p_{1\ max}$  to be encountered. This data is needed to make sure the actuator is able to provide a close-tight function within all the specified modes of operation.

### 7.3. Bürkert product filter



**Bürkert product filter – Get quickly to the right product**

You want to select products comfortably based on your technical requirements? Use the Bürkert product filter and find suitable articles for your application quickly and easily.

[Try out our product filter](#)

### 7.4. Ordering chart accessories

Description	Article no.
<b>Connections/Cables</b>	
Round plug M16, 8 pin (solder connection)	918299
Round plug M16, 8 pin with 5 m cable	787733
Round plug M16, 8 pin with 10 m cable	787734
Plug D-Sub HD15, 15 pin with 5 m cable	787735
Plug D-Sub HD15, 15 pin with 10 m cable	787736
<b>Adapters<sup>1)</sup></b>	
RS232 adapter for connection to a computer, connection with an extension cable (Article no. 917039)	654757
Extension cable for RS232 9 pin socket/plug 2 m	917039
RS422 adapter (RS485 compatible)	666370
USB adapter	670696

Description	Article no.
USB connection cable 2 m	772299
Adapter for manual setting of bus address	667525
Communication software Mass Flow Communicator	<a href="#">LINK ▶</a>
<b>Accessories for Fieldbus</b>	
<b>PROFIBUS-DP (B-coded)</b>	
Plug M12 <sup>2.)</sup>	918198
Socket M12 (coupling) <sup>2.)</sup>	918447
Y-junction <sup>2.)</sup>	902098
T-junction	918531
Termination resistor	902553
GSD-File (PROFIBUS), EDS-File (CANopen)	<a href="#">LINK ▶</a>
<b>CANopen (A-coded)</b>	
Plug M12 <sup>2.)</sup>	917115
Socket M12 (coupling) <sup>2.)</sup>	917116
Y-Stück <sup>2.)</sup>	788643
T-junction	On request
Termination resistor	On request
GSD-File (PROFIBUS), EDS-File (CANopen)	<a href="#">LINK ▶</a>

1.) The adapters serve mainly for initial operation or diagnosis. Those are not obligatory for continuous operation.

2.) The M12 single connectors as listed here are not suitable for their simultaneous use with the Y-piece for reasons of space. Please always use at least one commercially available overmoulded cable whose connector is usually smaller.

### 7.5. Adapter sketch

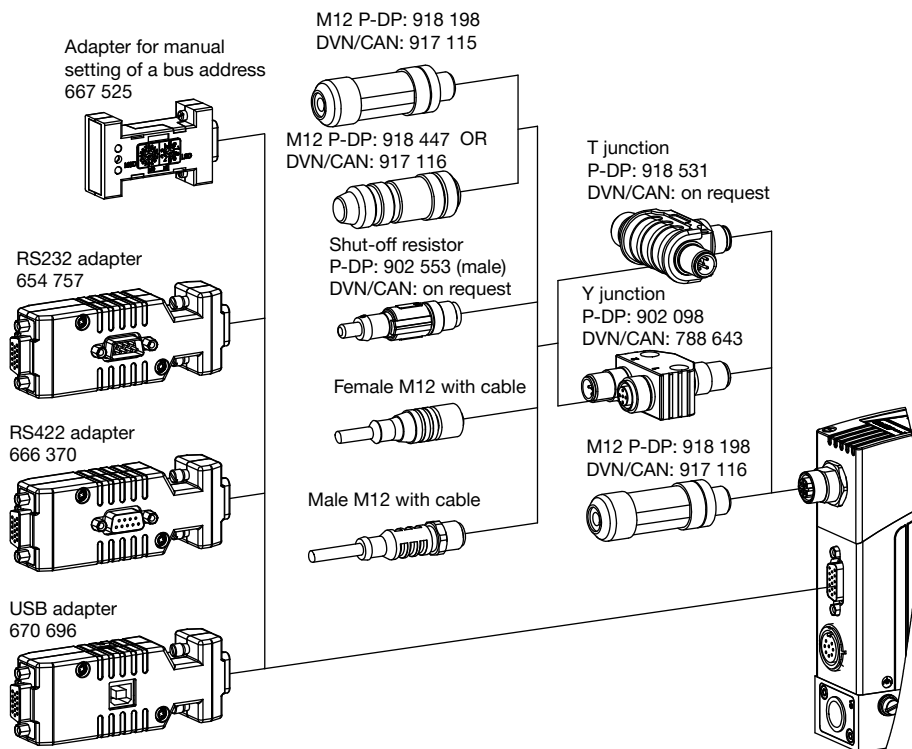

DTS 1000017532 EN Version: Q Status: RL (released | freigegeben | valide) printed: 06.08.2021

# Bürkert – Close to You

For up-to-date addresses  
please visit us at  
[www.burkert.com](http://www.burkert.com)

DTS 1000017532 EN Version: Q.Status: RL (released | freigegeben | validé) printed: 06.08.2021



## Product Enquiry Form - Mass Flow Controller For Gases

Thank you for your interest in our products! In order to provide you with optimum advice, please fill out the following form and send it to your **Bürkert representative** or e-mail address: [info@burkert.com](mailto:info@burkert.com). All information submitted will of course be kept strictly confidential.

Please fill in the **required fields!**  \*

\*Note: The interactive functions of this PDF may be restricted depending on the PDF reader used.

Personal Information			
Company		Contact person	
Customer no.		Department	
Street		Postcode / Town	
Telephone no.		Email	

Delivery			
MFC Application	MFM Application	Quantity	Required delivery date

Medium data			
Type of gas or gas mixture			
Medium temperature		°C /	°F
Ambient temperature		°C /	°F

Fluidic data					
Flow range $Q_{Nom}$		Min.		Max.	unit Ref. N <sup>1.)</sup> Ref. S <sup>1.)</sup>
Inlet pressure at $Q_{Nom}$ <sup>2.)</sup>	$p_1$	=		barg <sup>3.)</sup>	
Outlet pressure at $Q_{Nom}$	$p_2$	=		barg <sup>3.)</sup>	
Max. inlet pressure	$p_{1max}$	=		barg <sup>3.)</sup>	
Port connection	<b>Compression fitting</b>		<b>Subbase</b>	<b>Vacuum fitting</b>	
	<b>Thread:</b>		G (DIN ISO 228/1)	NPT (ANSI B1.2)	
			1/4"    3/8"	1/2"    3/4"	1"
Installation	horizontal, valve upright			vertical, upward flow	
	horizontal, valve horizontal			vertical, downward flow <sup>4.)</sup>	

1.) Reference conditions: Ref. N: T=0°C, P=1,013 bar(a); Ref. S: T=20°C, P=1,013 bar(a)

2.) Corresponds to the calibration pressure

3.) Please indicate all pressure values as overpressure to atmospheric pressure [barg] (g = relative pressure)

4.) Possible reduction of the setting range to 1:10 for a vertical downwards flow

Material specifications		
Body	Aluminium	Stainless steel
Seals	FKM	EPDM

Electrical data				
IP protection	Yes (IP65)		No (IP20 or better)	
Control / Communication <b>Note:</b> Please choose <b>one</b> of the following options!	<b>Normsignal</b>	<b>CANopen/büS</b>	<b>PROFIBUS DP</b>	<b>Industrial Ethernet</b>
	0 ... 5 V	CANopen		PROFINET
	0 ... 10 V	büS		Ethernet IP
	0 ... 20 mA			Modbus TCP
Connection <b>Note:</b> Please choose <b>one</b> of the following options!	4 ... 20 mA			EtherCAT
	D Sub socket	M12 socket	D Sub socket	(RJ45 always standard)
	Terminal block	Terminal block	M12 socket	

<b>Approvals / Conformities</b>
UL
ATEX II Cat. 3 G/D, IECEx
USP Class VI conformity
FDA conformity
EG 1935/2004 conformity

<b>Additional Requirements / Comment</b>

DTS 1000017532 EN Version: Q Status: RL (released | freigegeben | validé) printed: 06.08.2021