



Conductivity sensor

- Compact version for DN15...DN200
- Wide range of conductivity measurement thanks to different cells
- Broad range of process connections with various fittings

Product variants described in the data sheet may differ from the product presentation and description.

Can be combined with



Type 8619 ▶
multiCELL - Multi-channel and multi-function transmitter/controller



Type S020 ▶
Insertion fitting for flow or analytical measurement

Type description

The conductivity sensor consists of a compact probe with integrated electrodes. Four conductivity probes with different cell constants are available and offer a broad measurement range. The Pt1000 for automatic temperature compensation is integrated in the sensor housing.

The sensor delivers a raw signal and is fitted with a standard EN 175301-803 plug connector.

The sensor has to be connected to the Bürkert transmitter/controller Type 8619 multiCELL via a 4 x 1.5 mm² shielded cable (maximum cable length of 10 m).

The conductivity sensor can be installed into a pipe by using Insertion fitting Type S020 which is available in different materials (details see data sheet Type S020). In its longer version it can also be installed in tanks or containers by using an industrial immersion fitting.

Table of contents

1. General technical data	3
2. Approvals	4
2.1. Pressure Equipment Directive.....	4
Device used on a pipe	4
Device used on a vessel	4
3. Materials	4
3.1. Chemical Resistance Chart – Bürkert resistApp.....	4
4. Dimensions	5
4.1. Compact version.....	5
4.2. Compact version installed in a S020 fitting	5
4.3. Immersion kit for extended version of sensor.....	6
5. Performance specifications	6
5.1. Pressure temperature diagram.....	6
6. Product installation	7
6.1. Installation notes.....	7
Device used on a pipe	7
Device used on a vessel	7
6.2. Mounting options.....	7
Device used on a pipe	7
7. Product operation	8
7.1. Measuring principle	8
8. Product design and assembly	9
8.1. Product assembly	9
Device used on a pipe	9
Device used on a vessel	9
9. Product accessories	10
9.1. Accessory	10
10. Networking and combination with other Bürkert products	11
10.1. Combination with transmitter/controller and fitting	11
10.2. Combination with available S020 fittings DN	11
11. Ordering information	11
11.1. Bürkert eShop – Easy ordering and quick delivery.....	11
11.2. Recommendation regarding product selection	12
Device used on a pipe	12
Device used on a vessel	12
11.3. Bürkert product filter.....	12
11.4. Ordering chart.....	12
11.5. Ordering chart accessories.....	13

1. General technical data

Product properties	
Materials	
Please make sure the device materials are compatible with the fluid you are using. Detailed information can be found in chapter „3.1. Chemical Resistance Chart – Bürkert resistApp“ on page 4.	
Non wetted parts	
Housing	PC
Screws	Stainless steel
Pt1000	Stainless steel 1.4571 (316Ti)
Cable plug	PA
Wetted parts	
Sensor holder	PVDF
Seal	FKM (EPDM included in delivery)
Electrode	Stainless steel 1.4571 (316Ti) for cell constant C=0.01 or 0.1 Graphite for cell constant C=1.0 or 10
Compatibility	With fittings Type S020 See data sheet Type S020 ▶ for more information.
Pipe diameter	DN15...DN200
Temperature compensation	Automatic (integrated Pt1000) - reference temperature 25 °C
Connection cable	4 × 0.2...1.5 mm ² shielded
Cable length	Max. 10 m between Types 8220 and 8619
Electrical data	
Operating voltage	None
Output signal	Raw signal, to be connected to the multiCELL transmitter/controller Type 8619
Performance data	
Conductivity measurement	
Measuring range	0.05 µS/cm...200 mS/cm (depending on cell constant)
Measurement deviation	Typical: 3 % of measured value Max.: 5 % of measured value
Temperature measurement	
Measuring range	-50...+150 °C (-58...+302 °F)
Resolution	0.1 °C
Measurement deviation	±1 °C
Medium data	
Fluid temperature	With fitting Type S020 in: PVC: 0...+50 °C (+32...+122 °F) PP: 0...+80 °C (+32...+176 °F) PVDF, stainless steel, brass: 0...+100 °C (+32...+212 °F)
Fluid pressure (max.)	PN10 Detailed information can be found in chapter „5.1. Pressure temperature diagram“ on page 6.
Approvals and Certificates	
Standards	
Protection class according to IEC/EN 60529	IP65 with cable plug mounted and tightened
Directives	
CE directives	The applied standards, which verify conformity with the EU Directives, can be found on the EU Type Examination Certificate and/or the EU Declaration of conformity (if applicable)
Pressure equipment directives	Complying with Article 4, Paragraph 1 of 2014/68/EU directive Detailed information on the pressure equipment directive can be found in chapter „2.1. Pressure Equipment Directive“ on page 4.
Product connections	
Electrical connection	Cable plug according to EN 175301-803
Environment and installation	
Ambient temperature	0...+60 °C (+32...+140 °F) (operation and storage)
Relative air humidity	≤80 %, without condensation

2. Approvals

2.1. Pressure Equipment Directive

The device conforms to Article 4, Paragraph 1 of the Pressure Equipment Directive 2014/68/EU under the following conditions:

Device used on a pipe

Note:

- The data in the table is independent of the chemical compatibility of the material and the fluid.
- PS = maximum admissible pressure, DN = nominal diameter of the pipe

Type of fluid	Conditions
Fluid group 1, Article 4, Paragraph 1.c.i	DN ≤ 25
Fluid group 2, Article 4, Paragraph 1.c.i	DN ≤ 32 or PS*DN ≤ 1000
Fluid group 1, Article 4, Paragraph 1.c.ii	DN ≤ 25 or PS*DN ≤ 2000
Fluid group 2, Article 4, Paragraph 1.c.ii	DN ≤ 200 or PS ≤ 10 or PS*DN ≤ 5000

Device used on a vessel

Note:

- The data in the table is independent of the chemical compatibility of the material and the fluid.
- PS = maximum admissible pressure, V = vessel volume

Type of fluid	Conditions
Fluid group 1, Article 4, Paragraph 1.a.i	V > 1 L and PS*V ≤ 25 bar.L or PS ≤ 200 bar
Fluid group 2, Article 4, Paragraph 1.a.i	V > 1 L and PS*V ≤ 50 bar.L or PS ≤ 1000 bar
Fluid group 1, Article 4, Paragraph 1.a.ii	V > 1 L and PS*V ≤ 200 bar.L or PS ≤ 500 bar
Fluid group 2, Article 4, Paragraph 1.a.ii	PS > 10 bar and PS*V ≤ 10000 bar.L or PS ≤ 1000 bar

3. Materials

3.1. Chemical Resistance Chart – Bürkert resistApp

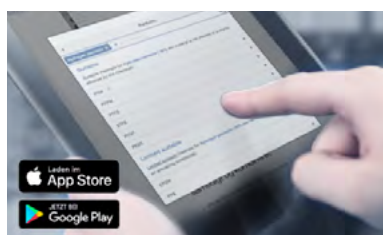

Bürkert resistApp – Chemical Resistance Chart

You want to ensure the reliability and durability of the materials in your individual application case? Verify your combination of media and materials on our website or in our resistApp.

[Start Chemical Resistance Check](#)

4. Dimensions

4.1. Compact version

Note:

Specifications in mm

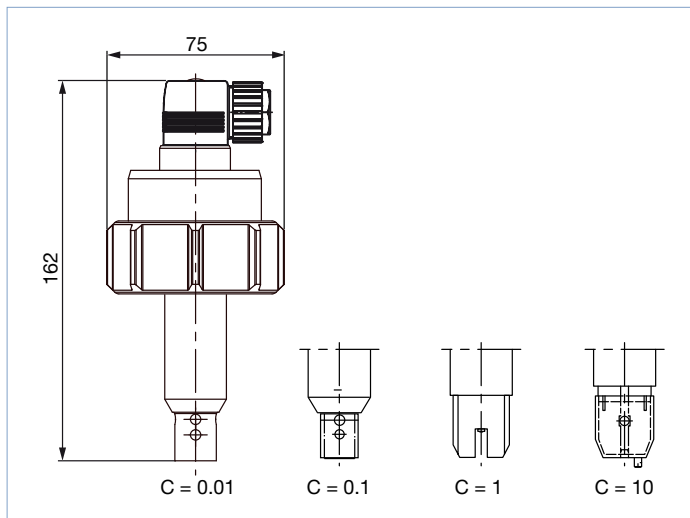

4.2. Compact version installed in a S020 fitting

Note:

Specifications in mm

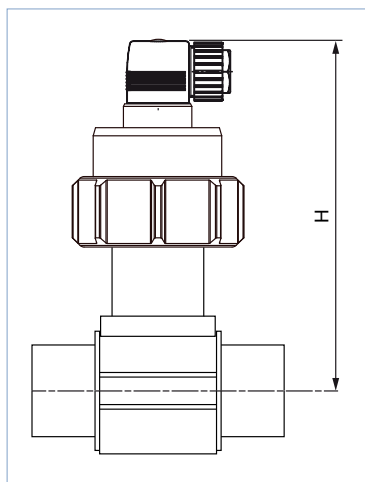

DN	H		
	T-Fitting	Plastic spigot ^{1.)}	Metal spigot
15	256.0	-	-
20	153.5	-	-
25	153.5	-	-
32	157.0	-	-
40	161.0	-	-
50	167.0	-	165.2
65	167.0	166.5	167.0
80	-	174.0	173.0
100	-	184.0	183.5
125	-	-	194.5
150	-	-	205.5
200	-	-	226.0

1.) Using fusion spigot (Article no. 418652, 418660 or 418644 in PP, PVDF or PE) for orifice DN65...DN100.

4.3. Immersion kit for extended version of sensor

Note:

Specifications in mm

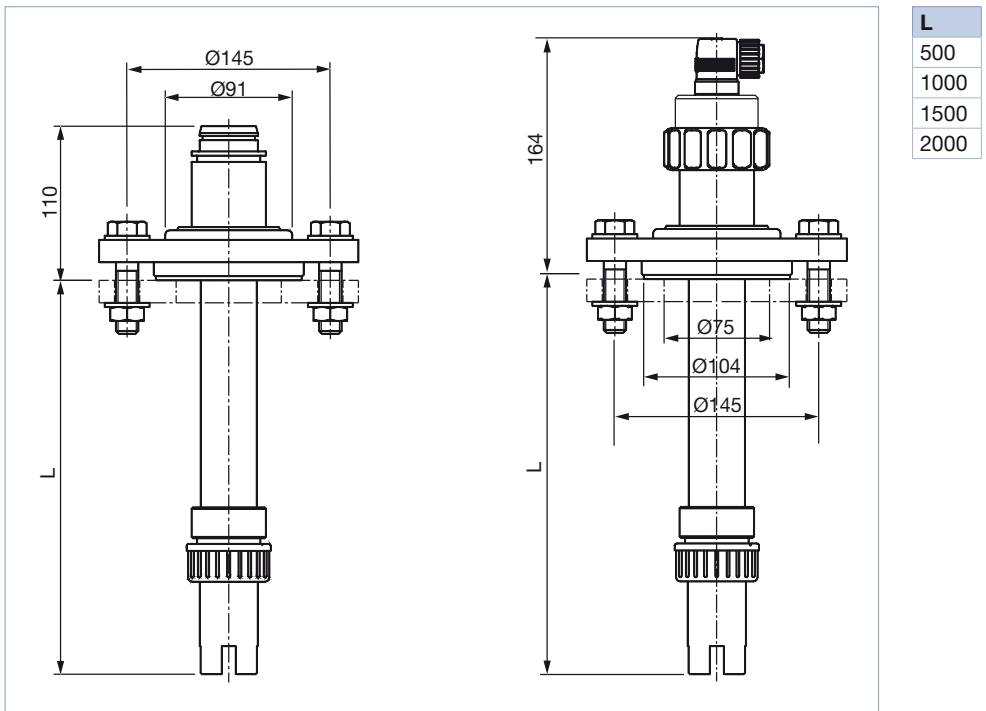

5. Performance specifications

5.1. Pressure temperature diagram

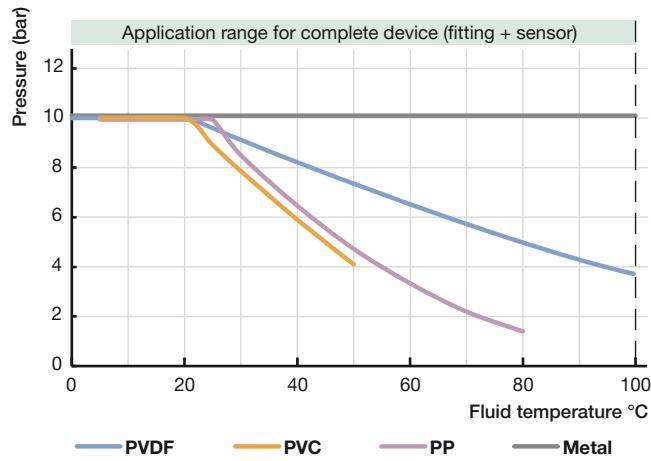

DTS 1000141283 EN Version: N Status: RL (released | freigegeben | validé) printed: 22.10.2020

6. Product installation

6.1. Installation notes

Device used on a pipe

Note:

The compact conductivity sensor Type 8220 can be installed into any Bürkert Insertion fitting (Type S020).

See [data sheet Type S020](#) ▶ for more information.

Installation example	Installation example
	<p>The compact conductivity sensor Type 8220 can be installed into any Bürkert Insertion fitting (Type S020). Select and install the required fitting onto the pipe, according to specific requirements of the sensor and fitting material (temperature and pressure). Then cautiously install the unit on the fitting and tighten with the nut.</p> <p>Detailed information on the assembly can be found in chapter „8.1. Product assembly“ on page 9.</p> <p>With a cell constant C=10, the opening hole of the small channel must be located on the flow inlet side.</p>

Device used on a vessel

Installation example	Installation example
	<p>An industrial immersion kit allows installation of the longer version of the sensor having a cell constant C=0.01, 0.1 or 1 into tanks or containers.</p> <p>The following lengths are available: 500, 1000, 1500, 2000 mm. Special lengths on request.</p> <p>Detailed information on the assembly can be found in chapter „8.1. Product assembly“ on page 9.</p> <p>Required accessories can be found in chapter „9. Product accessories“ on page 10.</p>

6.2. Mounting options

Device used on a pipe

Note:

- In order to get a reliable measurement, air bubbles must be avoided and the mounting location must ensure that the electrode is continuously and completely immersed in the flow stream.
- The transmitter must be protected from constant heat radiation and other environmental influences, such as direct exposure to sunlight.
- The sensor can be installed in any position.

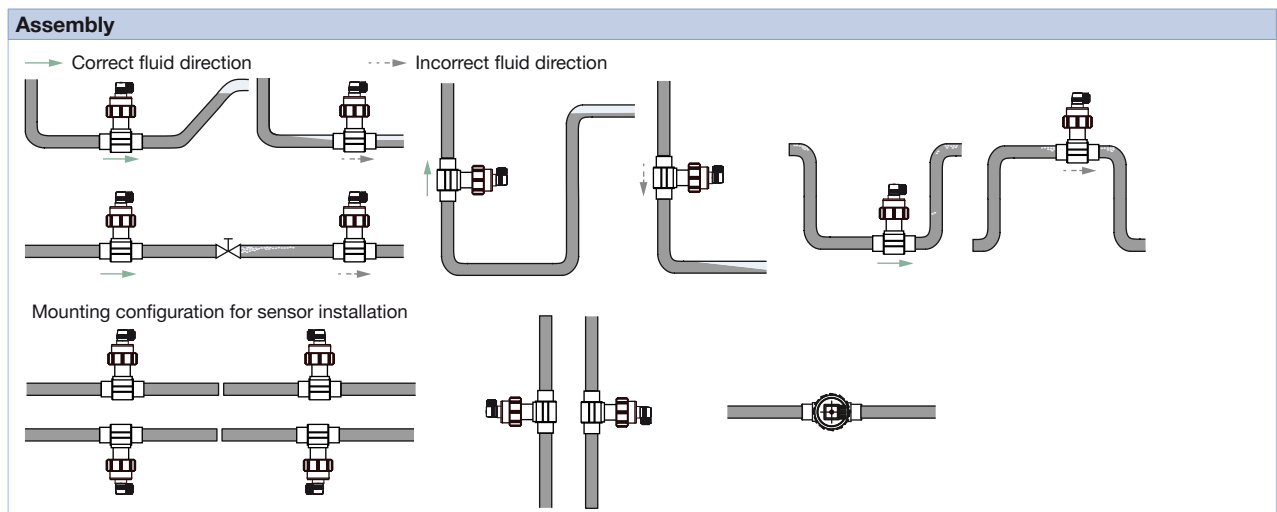

7. Product operation

7.1. Measuring principle

Conductivity is defined by the property of a solution to conduct electrical current. The charge carriers are ions (e.g. dissolved salts or acids).

In the simplest case the measurement cell consists of two metal electrodes which are set at a fixed distance apart and with a known specified surface. An AC voltage supplied from the connected transmitter/controller Type 8619 is applied to the electrodes. The measured current is a direct function of the quantity of ions contained in the solution, and with help of Ohm's law the conductivity is calculated. A 4...20 mA standard signal proportional to the conductivity is available as output signal at the connected transmitter.

There are many types of conductivity probes available, the measuring range of which varies greatly depending on the electrode assembly. To compensate for the geometry of the conductivity cell a cell constant is used: $\text{Conductivity [S/cm]} = \text{Measurement [S]} \times \text{Cell constant [1/cm]}$.

The conductivity sensor can be equipped with 4 cells with different constants $C=0.01$; 0.1 ; 1 and 10 .

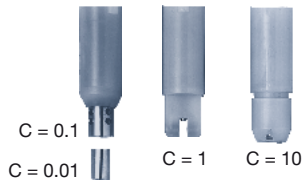

The sensor is selected according to the measuring range and medium by using the table below..

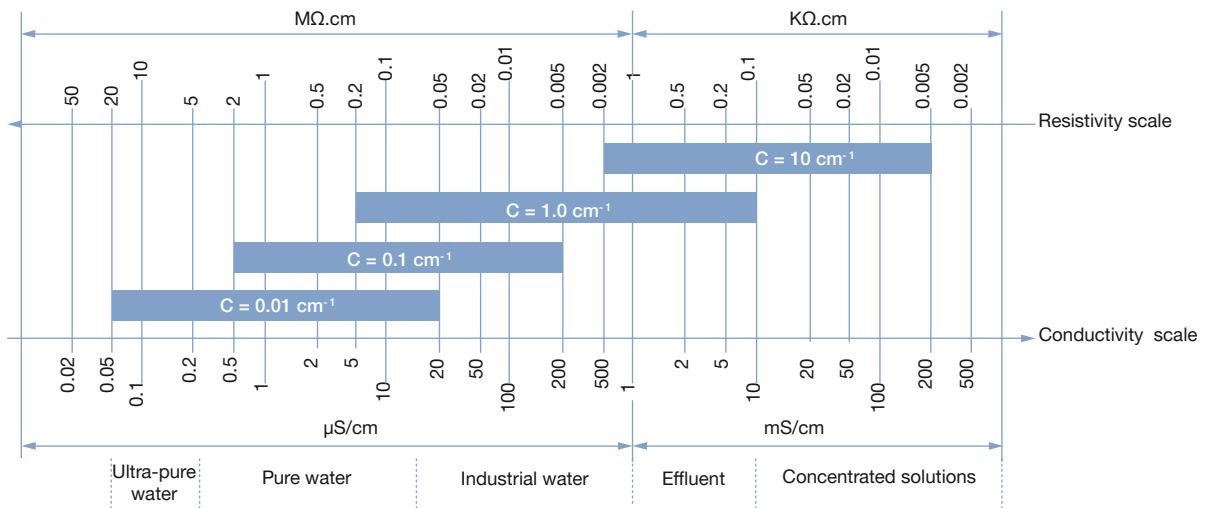

8. Product design and assembly

8.1. Product assembly

Device used on a pipe

Note:

The compact conductivity sensor 8220 can be installed into any Bürkert Insertion fitting (S020).

See [data sheet Type S020](#) ▶ for more information.

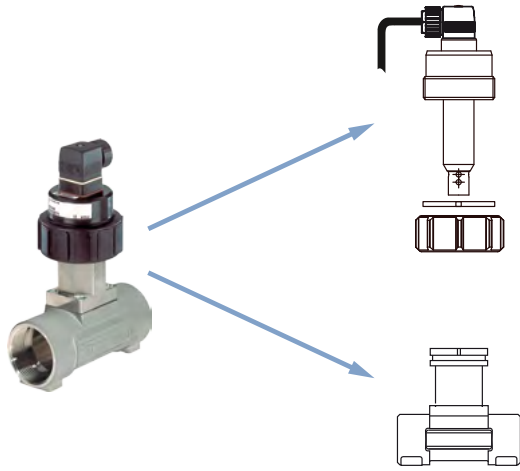

Device used on a vessel

Note:

See chapter „9. Product accessories“ on page 10 for more details on the accessories used.

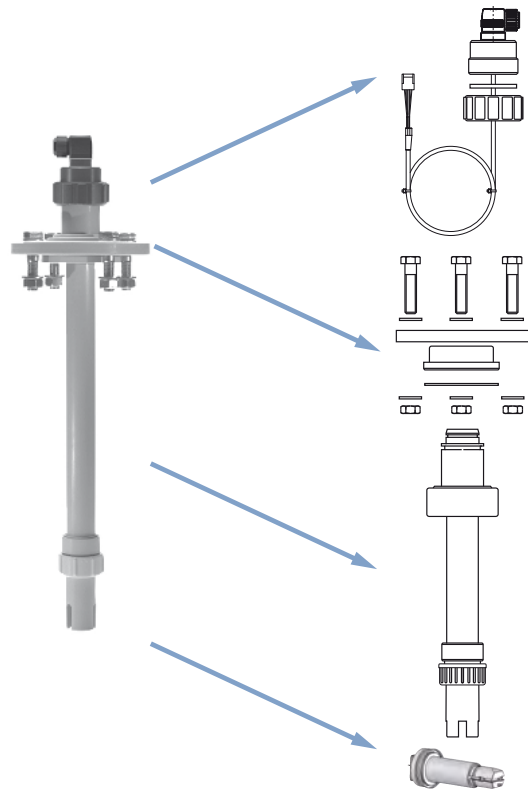

9. Product accessories

9.1. Accessory

Note:

- To enable the use of conductivity sensors on a tank, it is necessary to use the following accessories.
- See chapter „8.1. Product assembly“ on page 9 for further details on the product assembly of the conductivity sensor.

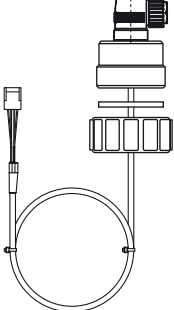
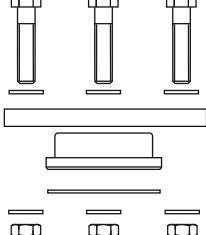
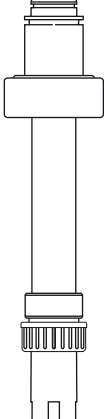
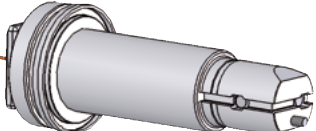
Accessory	Description
	Extension cable kit with defined cable length (for immersion fitting, to use with 8619 multi-CELL transmitter/controller)
	Fixing kit (flange DN65 with stainless steel screws)
	Immersion fitting in PP, with different lengths
	Conductivity probe with various cell constants (with stainless steel or graphite electrode) for mounting with immersion kit

10. Networking and combination with other Bürkert products

10.1. Combination with transmitter/controller and fitting

Example:

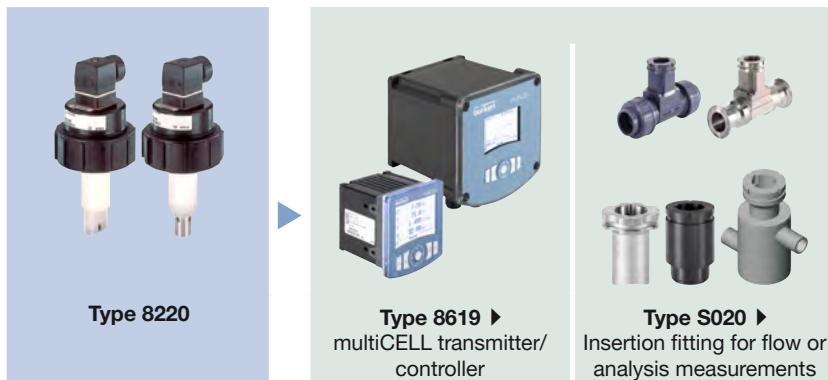

10.2. Combination with available S020 fittings DN

		DN15	DN32	DN50	DN65	DN100	DN200	
Available S020 fittings DN	T-Fitting	Available						
	Welding socket			Available				
	Fusion spigot			Available				
Conductivity measurement Type 8220		Note A						

Note A: Only use plastic fitting in analytical version with true union acc. to DIN 8063 (PVC), to DIN 16962 (PP) or to ISO 10931 (PVDF).

See **data sheet Type S020** for more information.

11. Ordering information

11.1. Bürkert eShop – Easy ordering and quick delivery



Bürkert eShop – Easy ordering and fast delivery

You want to find your desired Bürkert product or spare part quickly and order directly? Our online shop is available for you 24/7. Sign up and enjoy all the benefits.

[Order online now](#)

11.2. Recommendation regarding product selection

Device used on a pipe

Note:

A complete conductivity measurement equipment consists of a conductivity sensor Type 8220, a multiCELL transmitter/controller Type 8619 and a Bürkert Insertion fitting Type S020.

See [data sheet Type S020](#) and [data sheet Type 8619](#) for more information.

Three different components must be ordered in order to select a complete device. The following information is required:

- **Article no.** of the desired conductivity sensor **Type 8220** (see chapter „11.4. Ordering chart“ on page 12)
- **Article no.** of the desired multiCELL transmitter/controller **Type 8619**
- **Article no.** of the selected Insertion fitting **Type S020** (DN15...DN200)

Device used on a vessel

Note:

A conductivity sensor Type 8220 for tank installation is made up of a conductivity probe, an immersion kit which is consisting of an immersion fitting, an extension cable kit for immersion fitting, a fixing kit (flange DN65 with stainless steel screws) and has to be connected to a multiCELL transmitter/controller Type 8619 (see chapter „9. Product accessories“ on page 10).

See [data sheet Type S020](#) and [data sheet Type 8619](#) for more information.

Five different components must be ordered in order to select a complete device. The following information is required:

- **Article no.** of the desired conductivity probe – only probes with cell constant C=0.01, 0.1 and 1 are available (see chapter „11.5. Ordering chart accessories“ on page 13)
- **Article no.** of the immersion fitting (see chapter „11.5. Ordering chart accessories“ on page 13)
- **Article no.** of the extension cable kit for the immersion fitting (see chapter „11.5. Ordering chart accessories“ on page 13)
- **Article no.** of the fixing kit (flange DN65 with stainless steel screws, see chapter „11.5. Ordering chart accessories“ on page 13)
- **Article no.** of the desired multiCELL transmitter/controller **Type 8619**

11.3. Bürkert product filter



Bürkert product filter – Get quickly to the right product



















You want to select products comfortably based on your technical requirements? Use the Bürkert product filter and find suitable articles for your application quickly and easily.

[Try out our product filter](#)

11.4. Ordering chart

Cell constant [cm ⁻¹]	Measuring range	Electrode materials	Electrical connection	Article no.
0.01	0.05 µS/cm...20 µS/cm	Stainless steel	Cable plug (according to EN 175301-803)	426872
0.1	0.5 µS/cm...200 µS/cm			426873
1	5 µS/cm...10 mS/cm	Graphite		426874
10	0.5 mS/cm...200 mS/cm			426875

11.5. Ordering chart accessories

Description	Article no.
Set with 2 cable glands M20 × 1.5 + 2 neoprene flat seals for cable gland or plug + 2 screw-plugs M20 × 1.5 + 2 multiway seals 2 × 6 mm	449755 
Cable plug EN 175301-803 with cable gland - see Type 2508 ▶ (will be replaced with Type 2518)	438811 
Cable plug EN 175301-803 with NPT ½" reduction without cable gland - see Type 2509 ▶	162673 
Mounting ring (open) for S020 fitting	619205 
PC - nut for S020 fitting	619204 
Set with 1 green FKM + 1 black EPDM seal	552111 
Conductivity probe C=0.01 (with stainless steel electrode) for mounting with immersion kit	633367 
Conductivity probe C=0.1 (with stainless steel electrode) for mounting with immersion kit	631647 
Conductivity probe C=1 (with graphite electrode) for mounting with immersion kit	418217 
Immersion fitting in PP, L=0.5 m	419567 
Immersion fitting in PP, L=1.0 m	419568 
Immersion fitting in PP, L=1.5 m	419569 
Immersion fitting in PP, L=2.0 m	419570 
Extension cable kit including a 0.7 m cable (for immersion fitting, L ≤ 0.5 m or use with 8619 multiCELL transmitter/controller)	437615 
Extension cable kit including a 1.7 m cable (for immersion fitting, L ≤ 1.5 m or use with 8619 multiCELL transmitter/controller)	437617 
Extension cable kit including a 2.2 m cable (for immersion fitting, L ≤ 2.0 m or use with 8619 multiCELL transmitter/controller)	437618 
Fixing kit (flange DN65 with stainless steel screws)	413615 
Factory 2-point conductivity calibration certificate	550675 

Bürkert – Close to You

For up-to-date addresses
please visit us at
www.burkert.com

DTS 1000141283 EN Version: N Status: RL (released | freigegeben | validé) printed: 22.10.2020

